

DATI TECNICI

Montaggio	-
Impiego	autostrade e superstrade, strade urbane, strade di quartiere (interne), percorsi pedonali, parcheggi
Grado di protezione	IP 66 per la parte ottica e per il sistema d'alimentazione
Sistema ottico	lente con PMMA, moduli sostituibili LED, cloche PC-UV
Materiale	lega di alluminio, anodizzato
	0,024 m³ (48 W - 72 W) 0,033 m³ (96 W - 144 W)
Campo di temperatura del funzionamento	da -40°C a +40°C
Periodo di utilizzazione previsto	L90B10 - 100 000 h
Indice di resa cromatica CRI	>70
	49 A / 290 µs (48 W - 72 W) 24 A / 60 µs (96 W - 144 W) 85 A / 215 µs (192 W)
Frequenza della tensione di alimentazione	50/60Hz
Fattore di potenza	≥0.95
Numero di diodi	24 (48 W, 60 W, 72 W); 64 (96 W, 120 W, 144 W, 192 W)
Sistema di controllo	L'apparecchio può essere collegato a un sistema di controllo esterno e/o sensori tramite una presa compatibile con Zhaga Book 18.



TABELLA DELLE VARIANTI

Codice	Nome	Potenza LED	Potenza totale dell'apparecchio	Corrente di conduzione LED	Temperatura di colore della luce	Sorgente di luce LED¹	Sorgente di luce dell'apparecchio	Efficienza luminosa¹	Presa D4i	Peso netto
2225133/1/...²	CUDDLE II LED REG D4i 48	48 W	55 W	700 mA	2700 K	8150 lm	6950 lm	126 lm/W	1 ↑	5.6 kg
2225133/3/...²	CUDDLE II LED REG D4i 48	48 W	55 W	700 mA	3500 K	8650 lm	7350 lm	134 lm/W	1 ↑	5.6 kg
2225133/4/...²	CUDDLE II LED REG D4i 48	48 W	55 W	700 mA	4000 K	9150 lm	7800 lm	142 lm/W	1 ↑	5.6 kg
2225133/6/...²	CUDDLE II LED REG D4i 48	48 W	55 W	700 mA	5000 K	9150 lm	7800 lm	142 lm/W	1 ↑	5.6 kg
2225134/1/...²	CUDDLE II LED REG D4i 60	60 W	67 W	830 mA	2700 K	9300 lm	7950 lm	119 lm/W	1 ↑	5.6 kg
2225134/3/...²	CUDDLE II LED REG D4i 60	60 W	67 W	830 mA	3500 K	9850 lm	8400 lm	125 lm/W	1 ↑	5.6 kg
2225134/4/...²	CUDDLE II LED REG D4i 60	60 W	67 W	830 mA	4000 K	10450 lm	8900 lm	133 lm/W	1 ↑	5.6 kg
2225134/6/...²	CUDDLE II LED REG D4i 60	60 W	67 W	830 mA	5000 K	10450 lm	8900 lm	133 lm/W	1 ↑	5.6 kg
2225135/1/...²	CUDDLE II LED REG D4i 72	72 W	79 W	1000 mA	2700 K	10700 lm	9100 lm	115 lm/W	1 ↑	5.6 kg
2225135/3/...²	CUDDLE II LED REG D4i 72	72 W	79 W	1000 mA	3500 K	11350 lm	9700 lm	123 lm/W	1 ↑	5.6 kg
2225135/4/...²	CUDDLE II LED REG D4i 72	72 W	79 W	1000 mA	4000 K	12100 lm	10300 lm	130 lm/W	1 ↑	5.6 kg
2225135/6/...²	CUDDLE II LED REG D4i 72	72 W	79 W	1000 mA	5000 K	12100 lm	10300 lm	130 lm/W	1 ↑	5.6 kg
2225137/1/...²	CUDDLE II LED REG D4i 96	96 W	105 W	500 mA	2700 K	16000 lm	13650 lm	130 lm/W	1 ↑	8.6 kg
2225137/3/...²	CUDDLE II LED REG D4i 96	96 W	105 W	500 mA	3500 K	16950 lm	14450 lm	138 lm/W	1 ↑	8.6 kg
2225137/4/...²	CUDDLE II LED REG D4i 96	96 W	105 W	500 mA	4000 K	18000 lm	15350 lm	146 lm/W	1 ↑	8.6 kg
2225137/6/...²	CUDDLE II LED REG D4i 96	96 W	105 W	500 mA	5000 K	18000 lm	15350 lm	146 lm/W	1 ↑	8.6 kg
2225139/1/...²	CUDDLE II LED REG D4i 120	120 W	129 W	625 mA	2700 K	19250 lm	16400 lm	127 lm/W	1 ↑	8.6 kg
2225139/3/...²	CUDDLE II LED REG D4i 120	120 W	129 W	625 mA	3500 K	20500 lm	17450 lm	135 lm/W	1 ↑	8.6 kg
2225139/4/...²	CUDDLE II LED REG D4i 120	120 W	129 W	625 mA	4000 K	21700 lm	18500 lm	143 lm/W	1 ↑	8.6 kg
2225139/6/...²	CUDDLE II LED REG D4i 120	120 W	129 W	625 mA	5000 K	21700 lm	18500 lm	143 lm/W	1 ↑	8.6 kg
2225141/1/...²	CUDDLE II LED REG D4i 144	144 W	154 W	750 mA	2700 K	22350 lm	19050 lm	124 lm/W	1 ↑	8.6 kg
2225141/3/...²	CUDDLE II LED REG D4i 144	144 W	154 W	750 mA	3500 K	23750 lm	20250 lm	131 lm/W	1 ↑	8.6 kg
2225141/4/...²	CUDDLE II LED REG D4i 144	144 W	154 W	750 mA	4000 K	25150 lm	21450 lm	139 lm/W	1 ↑	8.6 kg
2225141/6/...²	CUDDLE II LED REG D4i 144	144 W	154 W	750 mA	5000 K	25150 lm	21450 lm	139 lm/W	1 ↑	8.6 kg
2225146/1/...²	CUDDLE II LED REG D4i 192	192 W	205 W	1000 mA	2700 K	27850 lm	23750 lm	116 lm/W	1 ↑	8.8 kg
2225146/3/...²	CUDDLE II LED REG D4i 192	192 W	205 W	1000 mA	3500 K	29600 lm	25250 lm	123 lm/W	1 ↑	8.8 kg

CUDDLE II LED REG D4I

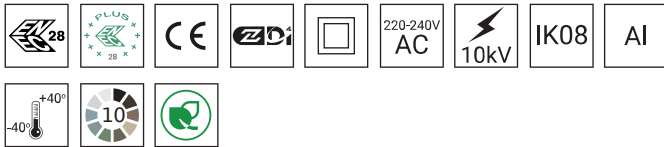

2225146/4/... ²	CUDDLE II LED REG D4i 192	192 W	205 W	1000 mA	4000 K	31350 lm	26700 lm	130 lm/W	1 ↑	8.8 kg
2225146/6/... ²	CUDDLE II LED REG D4i 192	192 W	205 W	1000 mA	5000 K	31350 lm	26700 lm	130 lm/W	1 ↑	8.8 kg
2225333/1/... ²	CUDDLE II LED REG D4i D 48	48 W	55 W	700 mA	2700 K	8150 lm	6950 lm	126 lm/W	1 ↓	5.6 kg
2225333/3/... ²	CUDDLE II LED REG D4i D 48	48 W	55 W	700 mA	3500 K	8650 lm	7350 lm	134 lm/W	1 ↓	5.6 kg
2225333/4/... ²	CUDDLE II LED REG D4i D 48	48 W	55 W	700 mA	4000 K	9150 lm	7800 lm	142 lm/W	1 ↓	5.6 kg
2225333/6/... ²	CUDDLE II LED REG D4i D 48	48 W	55 W	700 mA	5000 K	9150 lm	7800 lm	142 lm/W	1 ↓	5.6 kg
2225334/1/... ²	CUDDLE II LED REG D4i D 60	60 W	67 W	830 mA	2700 K	9300 lm	7950 lm	119 lm/W	1 ↓	5.6 kg
2225334/3/... ²	CUDDLE II LED REG D4i D 60	60 W	67 W	830 mA	3500 K	9850 lm	8400 lm	125 lm/W	1 ↓	5.6 kg
2225334/4/... ²	CUDDLE II LED REG D4i D 60	60 W	67 W	830 mA	4000 K	10450 lm	8900 lm	133 lm/W	1 ↓	5.6 kg
2225334/6/... ²	CUDDLE II LED REG D4i D 60	60 W	67 W	830 mA	5000 K	10450 lm	8900 lm	133 lm/W	1 ↓	5.6 kg
2225335/1/... ²	CUDDLE II LED REG D4i D 72	72 W	79 W	1000 mA	2700 K	10700 lm	9100 lm	115 lm/W	1 ↓	5.6 kg
2225335/3/... ²	CUDDLE II LED REG D4i D 72	72 W	79 W	1000 mA	3500 K	11350 lm	9700 lm	123 lm/W	1 ↓	5.6 kg
2225335/4/... ²	CUDDLE II LED REG D4i D 72	72 W	79 W	1000 mA	4000 K	12100 lm	10300 lm	130 lm/W	1 ↓	5.6 kg
2225335/6/... ²	CUDDLE II LED REG D4i D 72	72 W	79 W	1000 mA	5000 K	12100 lm	10300 lm	130 lm/W	1 ↓	5.6 kg
2225337/1/... ²	CUDDLE II LED REG D4i D 96	96 W	105 W	500 mA	2700 K	16000 lm	13650 lm	130 lm/W	1 ↓	8.6 kg
2225337/3/... ²	CUDDLE II LED REG D4i D 96	96 W	105 W	500 mA	3500 K	16950 lm	14450 lm	138 lm/W	1 ↓	8.6 kg
2225337/4/... ²	CUDDLE II LED REG D4i D 96	96 W	105 W	500 mA	4000 K	18000 lm	15350 lm	146 lm/W	1 ↓	8.6 kg
2225337/6/... ²	CUDDLE II LED REG D4i D 96	96 W	105 W	500 mA	5000 K	18000 lm	15350 lm	146 lm/W	1 ↓	8.6 kg
2225339/1/... ²	CUDDLE II LED REG D4i D 120	120 W	129 W	625 mA	2700 K	19250 lm	16400 lm	127 lm/W	1 ↓	8.6 kg
2225339/3/... ²	CUDDLE II LED REG D4i D 120	120 W	129 W	625 mA	3500 K	20500 lm	17450 lm	135 lm/W	1 ↓	8.6 kg
2225339/4/... ²	CUDDLE II LED REG D4i D 120	120 W	129 W	625 mA	4000 K	21700 lm	18500 lm	143 lm/W	1 ↓	8.6 kg
2225339/6/... ²	CUDDLE II LED REG D4i D 120	120 W	129 W	625 mA	5000 K	21700 lm	18500 lm	143 lm/W	1 ↓	8.6 kg
2225341/1/... ²	CUDDLE II LED REG D4i D 144	144 W	154 W	750 mA	2700 K	22350 lm	19050 lm	124 lm/W	1 ↓	8.6 kg
2225341/3/... ²	CUDDLE II LED REG D4i D 144	144 W	154 W	750 mA	3500 K	23750 lm	20250 lm	131 lm/W	1 ↓	8.6 kg
2225341/4/... ²	CUDDLE II LED REG D4i D 144	144 W	154 W	750 mA	4000 K	25150 lm	21450 lm	139 lm/W	1 ↓	8.6 kg
2225341/6/... ²	CUDDLE II LED REG D4i D 144	144 W	154 W	750 mA	5000 K	25150 lm	21450 lm	139 lm/W	1 ↓	8.6 kg
2225346/1/... ²	CUDDLE II LED REG D4i D 192	192 W	205 W	1000 mA	2700 K	27850 lm	23750 lm	116 lm/W	1 ↓	8.8 kg
2225346/3/... ²	CUDDLE II LED REG D4i D 192	192 W	205 W	1000 mA	3500 K	29600 lm	25250 lm	123 lm/W	1 ↓	8.8 kg
2225346/4/... ²	CUDDLE II LED REG D4i D 192	192 W	205 W	1000 mA	4000 K	31350 lm	26700 lm	130 lm/W	1 ↓	8.8 kg
2225346/6/... ²	CUDDLE II LED REG D4i D 192	192 W	205 W	1000 mA	5000 K	31350 lm	26700 lm	130 lm/W	1 ↓	8.8 kg
2225533/1/... ²	CUDDLE II LED REG D4i x2 48	48 W	55 W	700 mA	2700 K	8150 lm	6950 lm	126 lm/W	1 ↑ / 1 ↓	5.6 kg
2225533/3/... ²	CUDDLE II LED REG D4i x2 48	48 W	55 W	700 mA	3500 K	8650 lm	7350 lm	134 lm/W	1 ↑ / 1 ↓	5.6 kg
2225533/4/... ²	CUDDLE II LED REG D4i x2 48	48 W	55 W	700 mA	4000 K	9150 lm	7800 lm	142 lm/W	1 ↑ / 1 ↓	5.6 kg
2225533/6/... ²	CUDDLE II LED REG D4i x2 48	48 W	55 W	700 mA	5000 K	9150 lm	7800 lm	142 lm/W	1 ↑ / 1 ↓	5.6 kg
2225534/1/... ²	CUDDLE II LED REG D4i x2 60	60 W	67 W	830 mA	2700 K	9300 lm	7950 lm	119 lm/W	1 ↑ / 1 ↓	5.6 kg
2225534/3/... ²	CUDDLE II LED REG D4i x2 60	60 W	67 W	830 mA	3500 K	9850 lm	8400 lm	125 lm/W	1 ↑ / 1 ↓	5.6 kg
2225534/4/... ²	CUDDLE II LED REG D4i x2 60	60 W	67 W	830 mA	4000 K	10450 lm	8900 lm	133 lm/W	1 ↑ / 1 ↓	5.6 kg
2225534/6/... ²	CUDDLE II LED REG D4i x2 60	60 W	67 W	830 mA	5000 K	10450 lm	8900 lm	133 lm/W	1 ↑ / 1 ↓	5.6 kg
2225535/1/... ²	CUDDLE II LED REG D4i x2 72	72 W	79 W	1000 mA	2700 K	10700 lm	9100 lm	115 lm/W	1 ↑ / 1 ↓	5.6 kg
2225535/3/... ²	CUDDLE II LED REG D4i x2 72	72 W	79 W	1000 mA	3500 K	11350 lm	9700 lm	123 lm/W	1 ↑ / 1 ↓	5.6 kg
2225535/4/... ²	CUDDLE II LED REG D4i x2 72	72 W	79 W	1000 mA	4000 K	12100 lm	10300 lm	130 lm/W	1 ↑ / 1 ↓	5.6 kg
2225535/6/... ²	CUDDLE II LED REG D4i x2 72	72 W	79 W	1000 mA	5000 K	12100 lm	10300 lm	130 lm/W	1 ↑ / 1 ↓	5.6 kg
2225537/1/... ²	CUDDLE II LED REG D4i x2 96	96 W	105 W	500 mA	2700 K	16000 lm	13650 lm	130 lm/W	1 ↑ / 1 ↓	8.6 kg
2225537/3/... ²	CUDDLE II LED REG D4i x2 96	96 W	105 W	500 mA	3500 K	16950 lm	14450 lm	138 lm/W	1 ↑ / 1 ↓	8.6 kg
2225537/4/... ²	CUDDLE II LED REG D4i x2 96	96 W	105 W	500 mA	4000 K	18000 lm	15350 lm	146 lm/W	1 ↑ / 1 ↓	8.6 kg
2225537/6/... ²	CUDDLE II LED REG D4i x2 96	96 W	105 W	500 mA	5000 K	18000 lm	15350 lm	146 lm/W	1 ↑ / 1 ↓	8.6 kg
2225539/1/... ²	CUDDLE II LED REG D4i x2 120	120 W	129 W	625 mA	2700 K	19250 lm	16400 lm	127 lm/W	1 ↑ / 1 ↓	8.6 kg
2225539/3/... ²	CUDDLE II LED REG D4i x2 120	120 W	129 W	625 mA	3500 K	20500 lm	17450 lm	135 lm/W	1 ↑ / 1 ↓	8.6 kg
2225539/4/... ²	CUDDLE II LED REG D4i x2 120	120 W	129 W	625 mA	4000 K	21700 lm	18500 lm	143 lm/W	1 ↑ / 1 ↓	8.6 kg
2225539/6/... ²	CUDDLE II LED REG D4i x2 120	120 W	129 W	625 mA	5000 K	21700 lm	18500 lm	143 lm/W	1 ↑ / 1 ↓	8.6 kg
2225541/1/... ²	CUDDLE II LED REG D4i x2 144	144 W	154 W	750 mA	2700 K	22350 lm	19050 lm	124 lm/W	1 ↑ / 1 ↓	8.6 kg
2225541/3/... ²	CUDDLE II LED REG D4i x2 144	144 W	154 W	750 mA	3500 K	23750 lm	20250 lm	131 lm/W	1 ↑ / 1 ↓	8.6 kg
2225541/4/... ²	CUDDLE II LED REG D4i x2 144	144 W	154 W	750 mA	4000 K	25150 lm	21450 lm	139 lm/W	1 ↑ / 1 ↓	8.6 kg
2225541/6/... ²	CUDDLE II LED REG D4i x2 144	144 W	154 W	750 mA	5000 K	25150 lm	21450 lm	139 lm/W	1 ↑ / 1 ↓	8.6 kg
2225546/1/... ²	CUDDLE II LED REG D4i x2 192	192 W	205 W	1000 mA	2700 K	27850 lm	23750 lm	116 lm/W	1 ↑ / 1 ↓	8.8 kg
2225546/3/... ²	CUDDLE II LED REG D4i x2 192	192 W	205 W	1000 mA	3500 K	29600 lm	25250 lm	123 lm/W	1 ↑ / 1 ↓	8.8 kg

2225546/4/... ²	CUDDLE II LED REG D4i x2 192	192 W	205 W	1000 mA	4000 K	31350 lm	26700 lm	130 lm/W	1 ↑ / 1 ↓	8.8 kg
2225546/6/... ²	CUDDLE II LED REG D4i x2 192	192 W	205 W	1000 mA	5000 K	31350 lm	26700 lm	130 lm/W	1 ↑ / 1 ↓	8.8 kg

1) a causa della classe di precisione dei diodi, la tolleranza del valore è del +/- 5%

2) simbolo del sistema ottico scelto p.e. 2225133/6/T2 sta per l'apparecchio CUDDLE II LED REG D4i 48 5000K con il sistema ottico T2

↑ - presa D4i dall'alto, ↓ - presa D4i dal basso, ↓ ↑ - presa D4i dall'alto e dal basso

/A... - versione ALFA dell'apparecchio di illuminazione, ad esempio 2225133/A/1/T2 indica l'apparecchio CUDDLE II LED ALFA REG D4i 48 2700K con sistema ottico T2

* Per l'apparecchio CUDDLE II LED REG D4i con ottica P2 e PL, è disponibile come opzione un'ulteriore temperatura di colore: 5700K. In questo caso, il codice prodotto viene completato con il suffisso "/7". Esempio: 2225133/7/P2 - apparecchio CUDDLE II LED REG D4i 48W 5700K con ottica P2.

DIRETTIVE E NORME

DIRETTIVE: 2014/35/EU (OJ L 96, 29/03/2014, p.357), 2014/30/EU (OJ L 96, 29/03/2014, p.79), 2011/65/ EU RoHS (OJ L 174, 01.07.2011, p. 88), 2009/125/EC (OJ L 285, 31.10.2009, p. 10)

NORME: PN-EN IEC 60598-1: 2021-7, PN-EN 60598-2-3: 2006, PN-EN 60529: 2003, PN-EN 62262: 2003, PN-EN 62471:2010, PN-EN 55015: 2019, PN-EN 61547: 2009, PN-EN 61000-3-2: 2019, PN-EN 61000-3-3: 2014, PN-EN 62722-2-1 (tq=40°C)

Parametri luminosi presentati in base ai test di laboratorio secondo IESNA LM-79-19.

SCARICA DI CARICA DAL CORPO DELL'APPARECCHIO A LED

Per scaricare efficacemente la carica dall'alloggiamento dell'apparecchio a LED installato su un palo in materiale dielettrico (non conduttivo), è necessaria una delle seguenti soluzioni:

- messa a terra funzionale
- apparecchio a LED con un sistema di sicurezza aggiuntivo

DISEGNO TECNICO

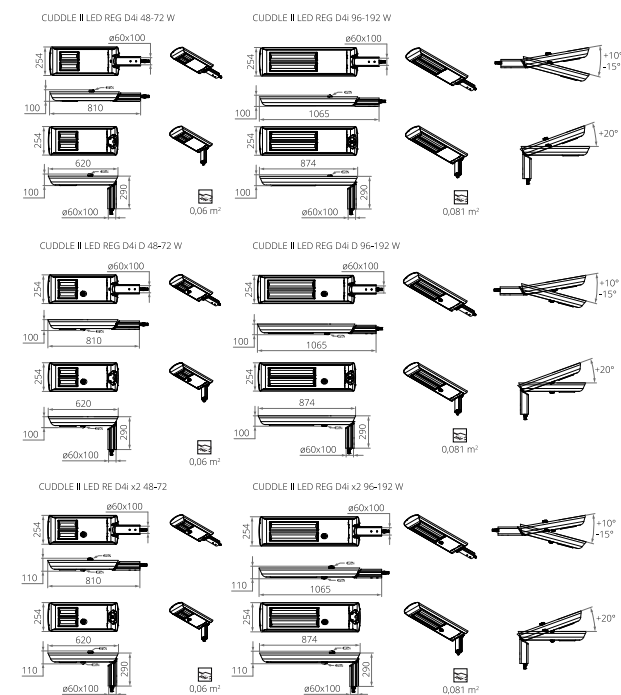

CURVE FOTOMETRICHE

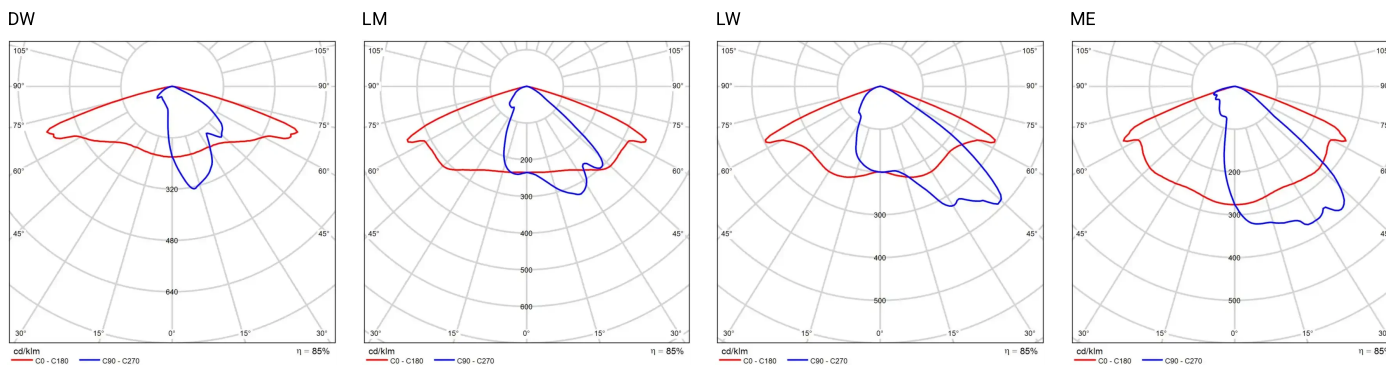

P2

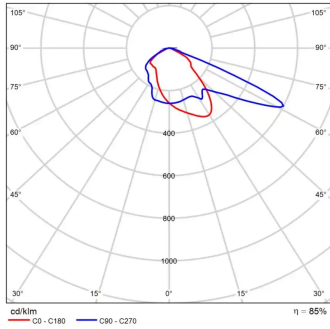

PL

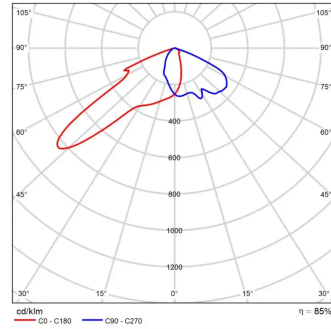

T2

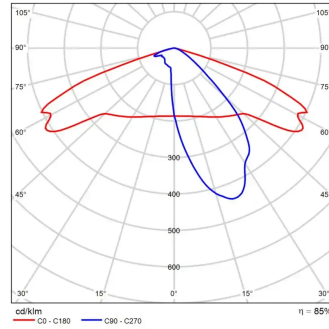

T3

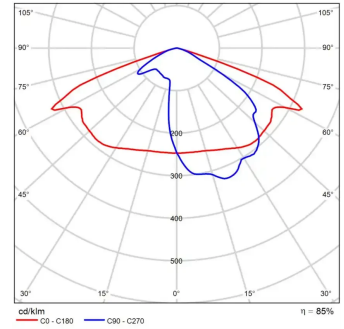

T4

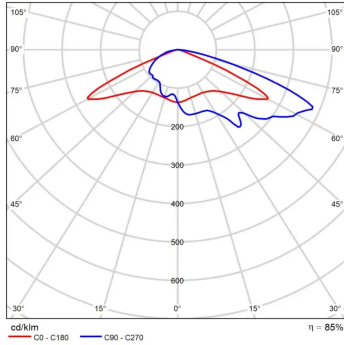

FUNZIONI DEL SISTEMA DI POTENZA

L'apparecchio dispone di serie delle seguenti funzioni del sistema di alimentazione intelligente:

- Possibilità di programmare l'oscuramento multistadio dell'apparecchio - fino a 5 intervalli di tempo nell'intervallo dal 10 al 100% della potenza nominale,
- Modulo LED dotato di protezione termica implementata tramite termistore NTC,
- Regolazione potenza/fluxo luminoso dell'apparecchio - possibilità di impostare un valore diverso da quello di catalogo, nel range 30-100% della potenza o del flusso nominale

NUMERO AMMESSO DI APPARECCHI SU UN CIRCUITO

Interruttori magnetotermici di tipo B o C

Apparecchi	Tipo	2A	4A	6A	10A	16A	20A	25A
CUDDLE II LED D4i 48, 60, 72W	B	4	9	13	23	37	46	58
	C	4	9	13	23	37	46	58
CUDDLE II LED D4i 96, 120, 144W	B	1	3	5	8	14	17	21
	C	1	4	7	11	19	23	29
CUDDLE II LED D4i 192W	B	0	1	2	3	5	6	7
	C	0	2	3	5	8	10	13

Fusibili - tipo gG e gL

Apparecchi	2A	4A	6A	10A	16A	20A	25A
CUDDLE II LED REG D4i 48W	4	9	13	23	37	46	58
CUDDLE II LED REG D4i 60W	4	9	13	23	37	46	58
CUDDLE II LED REG D4i 72W	4	9	13	23	37	46	58
CUDDLE II LED REG D4i 96W	2	4	7	11	19	23	29
CUDDLE II LED REG D4i 120W	2	4	7	11	19	23	29
CUDDLE II LED REG D4i 144W	2	4	7	11	19	23	29
CUDDLE II LED REG D4i 192W	0	2	4	6	12	17	22

CROMATICITÀ

Cromaticità	x	y
2700K	0,4582	0,4099
3500K	0,4080	0,3916
4000K	0,3825	0,3798
5000K	0,3451	0,3554

CODICE FOTOMETRICO

2700K	727/559
3500K	735/559
4000K	740/559
5000K	750/559