

DANE TECHNICZNE

Montaż	na wysięgniku z zakończeniem ø 60 x 100 mm wersja standardowa lub bezpośrednio na słupie z zakończeniem ø 60 x 180 mm wersja ALFA
Zastosowanie	autostrady i drogi ekspresowe, drogi miejskie, drogi osiedlowe (wewnętrzne), ciągi pieszych, parkingi
Kolor	inox / czarny
Stopień ochrony	IP 66 dla części optycznej i układu zasilającego
Układ optyczny	soczewki z PMMA, wymienny moduł LED, klosz z PC-UV
Materiał	stop aluminium, anodowany
Objętość jednostkowa	0,024 m ³ (CUDDLE II LED REG D4i 48 - 72 W) 0,033 m ³ (CUDDLE II LED REG D4i 96 - 144 W)
Zakres temperatur pracy	od -40°C do +40°C
Przewidywany czas eksploatacji	L90B10 - 100 000 h
Współczynnik oddawania barw CRI	>70
Prąd rozruchowy	49 A / 290 µs (CUDDLE II LED REG D4i 48 - 72) 24 A / 60 µs (CUDDLE II LED REG D4i 96 - 144) 85 A / 215 µs (CUDDLE II LED REG D4i 192)
Częstotliwość napięcia zasilania	50 - 60Hz
Współczynnik mocy	≥0.95
Liczba diod	24 - (48 W, 60 W, 72 W); 64 - (96 W, 120 W, 144 W, 192 W)
System sterowania	oprawa posiada możliwość podłączenia do zewnętrznego systemu sterowania i/lub sensorów poprzez gniazdo zgodne z Zhaga Book 18



TABELA WARIANTÓW

Kod	Nazwa	Moc LED	Moc całkowita	Prąd przewodzenia LED	Temperatura barwowa światła	Strumień świetlny LED ¹	Strumień świetlny ¹	Efektywność świetlna ¹	Gniazdo D4i	Waga netto
2225133/1/... ²	CUDDLE II LED REG D4i 48	48 W	55 W	700 mA	2700 K	8150 lm	6950 lm	126 lm/W	1 ↑	6.7 kg
2225133/3/... ²	CUDDLE II LED REG D4i 48	48 W	55 W	700 mA	3500 K	8650 lm	7350 lm	134 lm/W	1 ↑	6.7 kg
2225133/4/... ²	CUDDLE II LED REG D4i 48	48 W	55 W	700 mA	4000 K	9150 lm	7800 lm	142 lm/W	1 ↑	6.7 kg
2225133/6/... ²	CUDDLE II LED REG D4i 48	48 W	55 W	700 mA	5000 K	9150 lm	7800 lm	142 lm/W	1 ↑	6.7 kg
2225134/1/... ²	CUDDLE II LED REG D4i 60	60 W	67 W	830 mA	2700 K	9300 lm	7950 lm	119 lm/W	1 ↑	6.7 kg
2225134/3/... ²	CUDDLE II LED REG D4i 60	60 W	67 W	830 mA	3500 K	9850 lm	8400 lm	125 lm/W	1 ↑	6.7 kg
2225134/4/... ²	CUDDLE II LED REG D4i 60	60 W	67 W	830 mA	4000 K	10450 lm	8900 lm	133 lm/W	1 ↑	6.7 kg
2225134/6/... ²	CUDDLE II LED REG D4i 60	60 W	67 W	830 mA	5000 K	10450 lm	8900 lm	133 lm/W	1 ↑	6.7 kg
2225135/1/... ²	CUDDLE II LED REG D4i 72	72 W	79 W	1000 mA	2700 K	10700 lm	9100 lm	115 lm/W	1 ↑	6.7 kg
2225135/3/... ²	CUDDLE II LED REG D4i 72	72 W	79 W	1000 mA	3500 K	11350 lm	9700 lm	123 lm/W	1 ↑	6.7 kg
2225135/4/... ²	CUDDLE II LED REG D4i 72	72 W	79 W	1000 mA	4000 K	12100 lm	10300 lm	130 lm/W	1 ↑	6.7 kg
2225135/6/... ²	CUDDLE II LED REG D4i 72	72 W	79 W	1000 mA	5000 K	12100 lm	10300 lm	130 lm/W	1 ↑	6.7 kg
2225137/1/... ²	CUDDLE II LED REG D4i 96	96 W	105 W	500 mA	2700 K	16000 lm	13650 lm	130 lm/W	1 ↑	9 kg
2225137/3/... ²	CUDDLE II LED REG D4i 96	96 W	105 W	500 mA	3500 K	16950 lm	14450 lm	138 lm/W	1 ↑	9 kg
2225137/4/... ²	CUDDLE II LED REG D4i 96	96 W	105 W	500 mA	4000 K	18000 lm	15350 lm	146 lm/W	1 ↑	9 kg
2225137/6/... ²	CUDDLE II LED REG D4i 96	96 W	105 W	500 mA	5000 K	18000 lm	15350 lm	146 lm/W	1 ↑	9 kg
2225139/1/... ²	CUDDLE II LED REG D4i 120	120 W	129 W	625 mA	2700 K	19250 lm	16400 lm	127 lm/W	1 ↑	9 kg
2225139/3/... ²	CUDDLE II LED REG D4i 120	120 W	129 W	625 mA	3500 K	20500 lm	17450 lm	135 lm/W	1 ↑	9 kg
2225139/4/... ²	CUDDLE II LED REG D4i 120	120 W	129 W	625 mA	4000 K	21700 lm	18500 lm	143 lm/W	1 ↑	9 kg
2225139/6/... ²	CUDDLE II LED REG D4i 120	120 W	129 W	625 mA	5000 K	21700 lm	18500 lm	143 lm/W	1 ↑	9 kg
2225141/1/... ²	CUDDLE II LED REG D4i 144	144 W	154 W	750 mA	2700 K	22350 lm	19050 lm	124 lm/W	1 ↑	9 kg
2225141/3/... ²	CUDDLE II LED REG D4i 144	144 W	154 W	750 mA	3500 K	23750 lm	20250 lm	131 lm/W	1 ↑	9 kg
2225141/4/... ²	CUDDLE II LED REG D4i 144	144 W	154 W	750 mA	4000 K	25150 lm	21450 lm	139 lm/W	1 ↑	9 kg
2225141/6/... ²	CUDDLE II LED REG D4i 144	144 W	154 W	750 mA	5000 K	25150 lm	21450 lm	139 lm/W	1 ↑	9 kg

CUDDLE II LED REG D4i



2225146/1/... ²	CUDDLE II LED REG D4i 192	192 W	205 W	1000 mA	2700 K	27850 lm	23750 lm	116 lm/W	1 ↑	9 kg
2225146/3/... ²	CUDDLE II LED REG D4i 192	192 W	205 W	1000 mA	3500 K	29600 lm	25250 lm	123 lm/W	1 ↑	9 kg
2225146/4/... ²	CUDDLE II LED REG D4i 192	192 W	205 W	1000 mA	4000 K	31350 lm	26700 lm	130 lm/W	1 ↑	9 kg
2225146/6/... ²	CUDDLE II LED REG D4i 192	192 W	205 W	1000 mA	5000 K	31350 lm	26700 lm	130 lm/W	1 ↑	9 kg
2225333/1/... ²	CUDDLE II LED REG D4i D 48	48 W	55 W	700 mA	2700 K	8150 lm	6950 lm	126 lm/W	1 ↓	6.7 kg
2225333/3/... ²	CUDDLE II LED REG D4i D 48	48 W	55 W	700 mA	3500 K	8650 lm	7350 lm	134 lm/W	1 ↓	6.7 kg
2225333/4/... ²	CUDDLE II LED REG D4i D 48	48 W	55 W	700 mA	4000 K	9150 lm	7800 lm	142 lm/W	1 ↓	6.7 kg
2225333/6/... ²	CUDDLE II LED REG D4i D 48	48 W	55 W	700 mA	5000 K	9150 lm	7800 lm	142 lm/W	1 ↓	6.7 kg
2225334/1/... ²	CUDDLE II LED REG D4i D 60	60 W	67 W	830 mA	2700 K	9300 lm	7950 lm	119 lm/W	1 ↓	6.7 kg
2225334/3/... ²	CUDDLE II LED REG D4i D 60	60 W	67 W	830 mA	3500 K	9850 lm	8400 lm	125 lm/W	1 ↓	6.7 kg
2225334/4/... ²	CUDDLE II LED REG D4i D 60	60 W	67 W	830 mA	4000 K	10450 lm	8900 lm	133 lm/W	1 ↓	6.7 kg
2225334/6/... ²	CUDDLE II LED REG D4i D 60	60 W	67 W	830 mA	5000 K	10450 lm	8900 lm	133 lm/W	1 ↓	6.7 kg
2225335/1/... ²	CUDDLE II LED REG D4i D 72	72 W	79 W	1000 mA	2700 K	10700 lm	9100 lm	115 lm/W	1 ↓	6.7 kg
2225335/3/... ²	CUDDLE II LED REG D4i D 72	72 W	79 W	1000 mA	3500 K	11350 lm	9700 lm	123 lm/W	1 ↓	6.7 kg
2225335/4/... ²	CUDDLE II LED REG D4i D 72	72 W	79 W	1000 mA	4000 K	12100 lm	10300 lm	130 lm/W	1 ↓	6.7 kg
2225335/6/... ²	CUDDLE II LED REG D4i D 72	72 W	79 W	1000 mA	5000 K	12100 lm	10300 lm	130 lm/W	1 ↓	6.7 kg
2225337/1/... ²	CUDDLE II LED REG D4i D 96	96 W	105 W	500 mA	2700 K	16000 lm	13650 lm	130 lm/W	1 ↓	9 kg
2225337/3/... ²	CUDDLE II LED REG D4i D 96	96 W	105 W	500 mA	3500 K	16950 lm	14450 lm	138 lm/W	1 ↓	9 kg
2225337/4/... ²	CUDDLE II LED REG D4i D 96	96 W	105 W	500 mA	4000 K	18000 lm	15350 lm	146 lm/W	1 ↓	9 kg
2225337/6/... ²	CUDDLE II LED REG D4i D 96	96 W	105 W	500 mA	5000 K	18000 lm	15350 lm	146 lm/W	1 ↓	9 kg
2225339/1/... ²	CUDDLE II LED REG D4i D 120	120 W	129 W	625 mA	2700 K	19250 lm	16400 lm	127 lm/W	1 ↓	9 kg
2225339/3/... ²	CUDDLE II LED REG D4i D 120	120 W	129 W	625 mA	3500 K	20500 lm	17450 lm	135 lm/W	1 ↓	9 kg
2225339/4/... ²	CUDDLE II LED REG D4i D 120	120 W	129 W	625 mA	4000 K	21700 lm	18500 lm	143 lm/W	1 ↓	9 kg
2225339/6/... ²	CUDDLE II LED REG D4i D 120	120 W	129 W	625 mA	5000 K	21700 lm	18500 lm	143 lm/W	1 ↓	9 kg
2225341/1/... ²	CUDDLE II LED REG D4i D 144	144 W	154 W	750 mA	2700 K	22350 lm	19050 lm	124 lm/W	1 ↓	9 kg
2225341/3/... ²	CUDDLE II LED REG D4i D 144	144 W	154 W	750 mA	3500 K	23750 lm	20250 lm	131 lm/W	1 ↓	9 kg
2225341/4/... ²	CUDDLE II LED REG D4i D 144	144 W	154 W	750 mA	4000 K	25150 lm	21450 lm	139 lm/W	1 ↓	9 kg
2225341/6/... ²	CUDDLE II LED REG D4i D 144	144 W	154 W	750 mA	5000 K	25150 lm	21450 lm	139 lm/W	1 ↓	9 kg
2225346/1/... ²	CUDDLE II LED REG D4i D 192	192 W	205 W	1000 mA	2700 K	27850 lm	23750 lm	116 lm/W	1 ↓	9 kg
2225346/3/... ²	CUDDLE II LED REG D4i D 192	192 W	205 W	1000 mA	3500 K	29600 lm	25250 lm	123 lm/W	1 ↓	9 kg
2225346/4/... ²	CUDDLE II LED REG D4i D 192	192 W	205 W	1000 mA	4000 K	31350 lm	26700 lm	130 lm/W	1 ↓	9 kg
2225346/6/... ²	CUDDLE II LED REG D4i D 192	192 W	205 W	1000 mA	5000 K	31350 lm	26700 lm	130 lm/W	1 ↓	9 kg
2225533/1/... ²	CUDDLE II LED REG D4i x2 48	48 W	55 W	700 mA	2700 K	8150 lm	6950 lm	126 lm/W	1 ↑ / 1 ↓	6.7 kg
2225533/3/... ²	CUDDLE II LED REG D4i x2 48	48 W	55 W	700 mA	3500 K	8650 lm	7350 lm	134 lm/W	1 ↑ / 1 ↓	6.7 kg
2225533/4/... ²	CUDDLE II LED REG D4i x2 48	48 W	55 W	700 mA	4000 K	9150 lm	7800 lm	142 lm/W	1 ↑ / 1 ↓	6.7 kg
2225533/6/... ²	CUDDLE II LED REG D4i x2 48	48 W	55 W	700 mA	5000 K	9150 lm	7800 lm	142 lm/W	1 ↑ / 1 ↓	6.7 kg
2225534/1/... ²	CUDDLE II LED REG D4i x2 60	60 W	67 W	830 mA	2700 K	9300 lm	7950 lm	119 lm/W	1 ↑ / 1 ↓	6.7 kg
2225534/3/... ²	CUDDLE II LED REG D4i x2 60	60 W	67 W	830 mA	3500 K	9850 lm	8400 lm	125 lm/W	1 ↑ / 1 ↓	6.7 kg
2225534/4/... ²	CUDDLE II LED REG D4i x2 60	60 W	67 W	830 mA	4000 K	10450 lm	8900 lm	133 lm/W	1 ↑ / 1 ↓	6.7 kg
2225534/6/... ²	CUDDLE II LED REG D4i x2 60	60 W	67 W	830 mA	5000 K	10450 lm	8900 lm	133 lm/W	1 ↑ / 1 ↓	6.7 kg
2225535/1/... ²	CUDDLE II LED REG D4i x2 72	72 W	79 W	1000 mA	2700 K	10700 lm	9100 lm	115 lm/W	1 ↑ / 1 ↓	6.7 kg
2225535/3/... ²	CUDDLE II LED REG D4i x2 72	72 W	79 W	1000 mA	3500 K	11350 lm	9700 lm	123 lm/W	1 ↑ / 1 ↓	6.7 kg
2225535/4/... ²	CUDDLE II LED REG D4i x2 72	72 W	79 W	1000 mA	4000 K	12100 lm	10300 lm	130 lm/W	1 ↑ / 1 ↓	6.7 kg
2225535/6/... ²	CUDDLE II LED REG D4i x2 72	72 W	79 W	1000 mA	5000 K	12100 lm	10300 lm	130 lm/W	1 ↑ / 1 ↓	6.7 kg
2225537/1/... ²	CUDDLE II LED REG D4i x2 96	96 W	105 W	500 mA	2700 K	16000 lm	13650 lm	130 lm/W	1 ↑ / 1 ↓	9 kg
2225537/3/... ²	CUDDLE II LED REG D4i x2 96	96 W	105 W	500 mA	3500 K	16950 lm	14450 lm	138 lm/W	1 ↑ / 1 ↓	9 kg
2225537/4/... ²	CUDDLE II LED REG D4i x2 96	96 W	105 W	500 mA	4000 K	18000 lm	15350 lm	146 lm/W	1 ↑ / 1 ↓	9 kg
2225537/6/... ²	CUDDLE II LED REG D4i x2 96	96 W	105 W	500 mA	5000 K	18000 lm	15350 lm	146 lm/W	1 ↑ / 1 ↓	9 kg
2225539/1/... ²	CUDDLE II LED REG D4i x2 120	120 W	129 W	625 mA	2700 K	19250 lm	16400 lm	127 lm/W	1 ↑ / 1 ↓	9 kg
2225539/3/... ²	CUDDLE II LED REG D4i x2 120	120 W	129 W	625 mA	3500 K	20500 lm	17450 lm	135 lm/W	1 ↑ / 1 ↓	9 kg
2225539/4/... ²	CUDDLE II LED REG D4i x2 120	120 W	129 W	625 mA	4000 K	21700 lm	18500 lm	143 lm/W	1 ↑ / 1 ↓	9 kg
2225539/6/... ²	CUDDLE II LED REG D4i x2 120	120 W	129 W	625 mA	5000 K	21700 lm	18500 lm	143 lm/W	1 ↑ / 1 ↓	9 kg
2225541/1/... ²	CUDDLE II LED REG D4i x2 144	144 W	154 W	750 mA	2700 K	22350 lm	19050 lm	124 lm/W	1 ↑ / 1 ↓	9 kg
2225541/3/... ²	CUDDLE II LED REG D4i x2 144	144 W	154 W	750 mA	3500 K	23750 lm	20250 lm	131 lm/W	1 ↑ / 1 ↓	9 kg
2225541/4/... ²	CUDDLE II LED REG D4i x2 144	144 W	154 W	750 mA	4000 K	25150 lm	21450 lm	139 lm/W	1 ↑ / 1 ↓	9 kg
2225541/6/... ²	CUDDLE II LED REG D4i x2 144	144 W	154 W	750 mA	5000 K	25150 lm	21450 lm	139 lm/W	1 ↑ / 1 ↓	9 kg

2225546/1/... ²	CUDDLE II LED REG D4i x2 192	192 W	205 W	1000 mA	2700 K	27850 lm	23750 lm	116 lm/W	1 ↑ / 1 ↓	9 kg
2225546/3/... ²	CUDDLE II LED REG D4i x2 192	192 W	205 W	1000 mA	3500 K	29600 lm	25250 lm	123 lm/W	1 ↑ / 1 ↓	9 kg
2225546/4/... ²	CUDDLE II LED REG D4i x2 192	192 W	205 W	1000 mA	4000 K	31350 lm	26700 lm	130 lm/W	1 ↑ / 1 ↓	9 kg
2225546/6/... ²	CUDDLE II LED REG D4i x2 192	192 W	205 W	1000 mA	5000 K	31350 lm	26700 lm	130 lm/W	1 ↑ / 1 ↓	9 kg

1) ze względu na klasę dokładności diod tolerancja wartości wynosi +/- 5%

2) symbol wybranego układu optycznego np. 2225133/6/T2 to oprawa CUDDLE II LED REG D4i 48 5000K z układem optycznym T2

↑ - gniazdo D4i od góry, ↓ - gniazdo D4i od dołu, ↓ ↑ - gniazdo D4i od góry i dołu

/A/... - wersja ALFA oprawy z dłuższą głowicą np. 2225133/A/1/ to oprawa CUDDLE II LED ALFA REG D4i 48 2700K z układem optycznym T2

* Dla oprawy CUDDLE II LED REG D4i z układem optycznym P2 oraz PL istnieje

możliwość wyboru dodatkowej temperatury barwowej światła: 5700K. Kod produktu uzupełniony jest wtedy o oznaczenie „/7”. Przykład: 2225133/7/P2 – oprawa CUDDLE II LED REG D4i 48W 5700K z układem optycznym P2

DYREKTYWY I NORMY

DYREKTYWY: 2014/35/UE (Dz. Urz.UE L 96, 29.03.2014, str.357), 2014/30/UE (Dz. Urz.UE L 96, 29.03.2014, str.79), 2011/65/UE RoHS (Dz. Urz.UE L 174, 01.07.2011, str.88), 2009/125/WE (Dz. Urz.UE L 285, 31.10.2009, str.10)

NORMY: PN-EN IEC 60598-1: 2021, PN-EN 60598-2-3: 2006, PN-EN 60529: 2003, PN-EN 62262: 2003, PN-EN 62471:2010, PN-EN 55015: 2019, PN-EN 61547: 2009, PN-EN 61000-3-2: 2019, PN-EN 61000-3-3: 2013, PN-EN 62722-2-1 (tq=40°C)

Parametry świetlne przedstawione na podstawie badań laboratoryjnych według IESNA LM-79-19

ODPROWADZENIA ŁADUNKU Z OBUDOWY OPRAWY LED

W celu skutecznego odprowadzenia ładunku z obudowy oprawy LED zainstalowanej na słupie z materiału dielektrycznego (nieprzewodzącego) wymagane jest zastosowanie jednego z poniższych rozwiązań:

- uzziemienie funkcjonalne
- oprawa LED z dodatkowym układem zabezpieczającym

CUDDLE II LED REG D4I

RYSUNEK TECHNICZNY

CUDDLE II LED REG D4i 48W, 60W, 72W

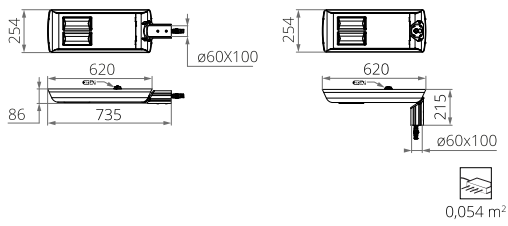

CUDDLE II LED REG D4i 96W, 120W, 144W, 196W

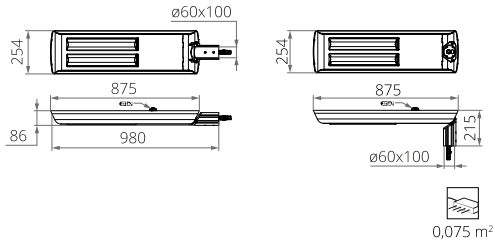

CUDDLE II LED ALFA REG D4i 48W, 60W, 72W

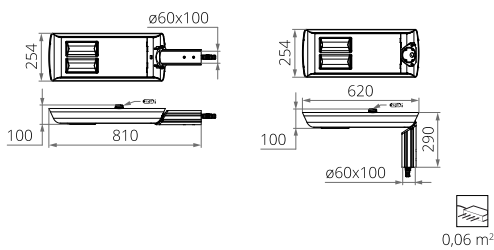

CUDDLE II LED ALFA REG D4i 96W, 120W, 144W, 196W

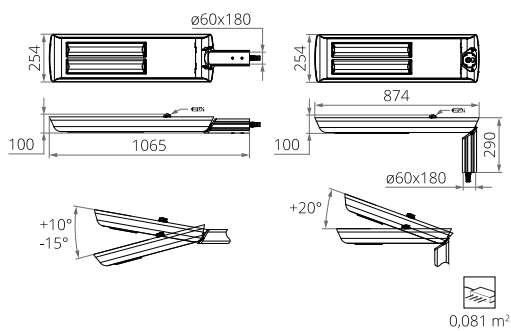

KRZYWE FOTOMETRYCZNE

DW

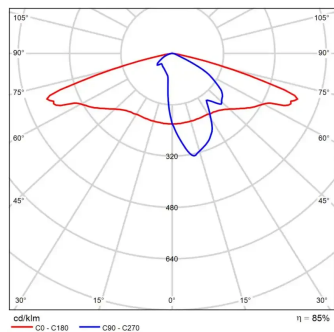

LM

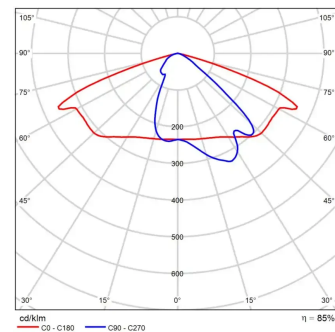

LW

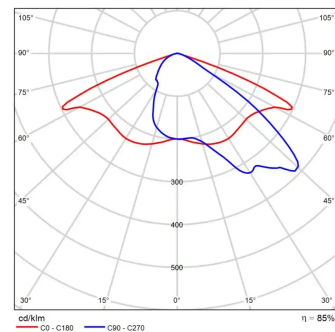

ME

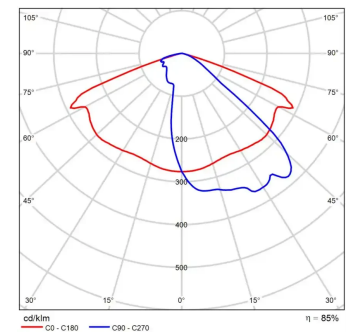

P2

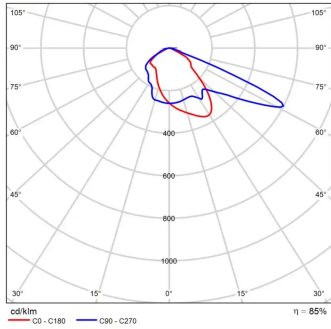

PL

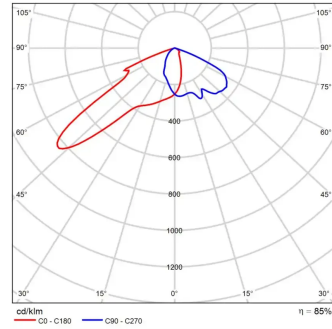

T2

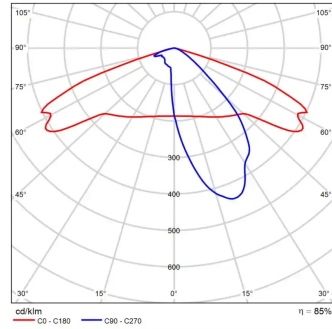

T3

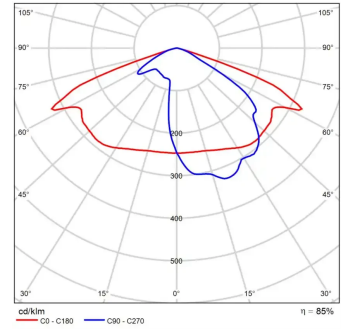

T4

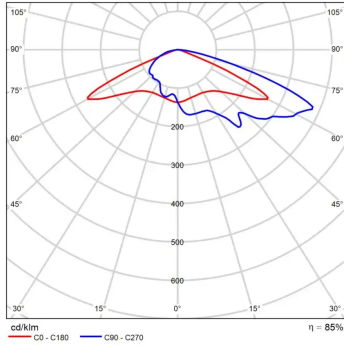

FUNKCJE UKŁADU ZASILAJĄCEGO

Oprawa standardowo posiada następujące funkcje inteligentnego układu zasilającego:

- Możliwość zaprogramowania wielostopniowego ściemnienia oprawy - do 5 przedziałów czasowych w zakresie od 10 do 100% mocy nominalnej,
- Moduł LED wyposażony w zabezpieczenie termiczne realizowane za pomocą termistora NTC,
- Regulacja mocy/strumienia świetlnego oprawy - opcja ustawienia innej wartości niż katalogowa, w zakresie 30-100% mocy lub nominalnego strumienia

DOPUSZCZALNA ILOŚĆ OPRAW NA JEDNYM OBWODZIE

Wyłączniki nadprądowe MCB typu B lub C

Oprawa	Typ	2A	4A	6A	10A	16A	20A	25A
CUDDLE II LED D4i 48, 60, 72W	B	4	9	13	23	37	46	58
	C	4	9	13	23	37	46	58
CUDDLE II LED D4i 96, 120, 144W	B	1	3	5	8	14	17	21
	C	1	4	7	11	19	23	29
CUDDLE II LED D4i 192W	B	0	1	2	3	5	6	7
	C	0	2	3	5	8	10	13

Bezpieczniki topikowe – typ gG i gL

Oprawa	2A	4A	6A	10A	16A	20A	25A
CUDDLE II LED REG D4i 48W	4	9	13	23	37	46	58
CUDDLE II LED REG D4i 60W	4	9	13	23	37	46	58
CUDDLE II LED REG D4i 72W	4	9	13	23	37	46	58
CUDDLE II LED REG D4i 96W	2	4	7	11	19	23	29
CUDDLE II LED REG D4i 120W	2	4	7	11	19	23	29
CUDDLE II LED REG D4i 144W	2	4	7	11	19	23	29
CUDDLE II LED REG D4i 192W	0	2	4	6	12	17	22

CHROMATYCZNOŚĆ

Chromatyczność	x	y
2700K	0,4582	0,4099
3500K	0,4080	0,3916
4000K	0,3825	0,3798
5000K	0,3451	0,3554

KOD FOTOMETRYCZNY

2700K	727/559
3500K	735/559
4000K	740/559
5000K	750/559