

CUDDLE II LED REG NEMA



TECHNICAL DATA

Assembly	directly on column with \varnothing 60 x 180 mm ending or on extension arm with \varnothing 60 x 100 mm ending
Application	motorways and expressway, urban roads, residential roads (internal), pedestrians, parkings
Colour	inox / black
Ingress protection	IP 66 for the optical part and the driver
Material	anodised aluminium alloy
Unit volume	0,029 m ³ (48 W - 72 W) 0,038 m ³ (96 W - 192 W)
Operating temperature range	from -40°C to +40°C
Expected useful lifetime	L90B10 - 100 000 h
CRI	>70
Inrush current	43 A / 260 μ s (48 W - 72 W) 77 A / 150 μ s (96 W - 144 W) 11,5 A / 1320 μ s (192 W)
Input voltage frequency	50/60Hz
Power factor	\geq 0.95
Number of LED	24 (48 W, 60 W, 72 W), 64 (96 W, 120 W, 144 W, 192 W)
Control system	The luminaire can be connected to an external control system via a 5-pin socket compatible with ANSI C136.41 (optional installation of a 7-pin socket). Standard communication interface: DALI (optional 1-10V analog signal support).



TABLE OF VARIANTS

Code	Symbol	LED power	Luminaire power consumption	LED forward current	Colour temperature (CCT)	LEDs luminous flux ¹	Luminaire luminous flux ¹	Luminous efficacy ¹	Net weight
2224133/1/... ²	CUDDLE II LED REG 48 NEMA	48 W	55 W	700 mA	2700 K	8150 lm	6950 lm	126 lm/W	6.9 kg
2224133/3/... ²	CUDDLE II LED REG 48 NEMA	48 W	55 W	700 mA	3500 K	8650 lm	7350 lm	134 lm/W	6.9 kg
2224133/4/... ²	CUDDLE II LED REG 48 NEMA	48 W	55 W	700 mA	4000 K	9150 lm	7800 lm	142 lm/W	6.9 kg
2224133/6/... ²	CUDDLE II LED REG 48 NEMA	48 W	55 W	700 mA	5000 K	9150 lm	7800 lm	142 lm/W	6.9 kg
2224134/1/... ²	CUDDLE II LED REG 60 NEMA	60 W	67 W	830 mA	2700 K	9300 lm	7950 lm	119 lm/W	6.9 kg
2224134/3/... ²	CUDDLE II LED REG 60 NEMA	60 W	67 W	830 mA	3500 K	9850 lm	8400 lm	125 lm/W	6.9 kg
2224134/4/... ²	CUDDLE II LED REG 60 NEMA	60 W	67 W	830 mA	4000 K	10450 lm	8900 lm	133 lm/W	6.9 kg
2224134/6/... ²	CUDDLE II LED REG 60 NEMA	60 W	67 W	830 mA	5000 K	10450 lm	8900 lm	133 lm/W	6.9 kg
2224135/1/... ²	CUDDLE II LED REG 72 NEMA	72 W	79 W	1000 mA	2700 K	10700 lm	9100 lm	115 lm/W	6.9 kg
2224135/3/... ²	CUDDLE II LED REG 72 NEMA	72 W	79 W	1000 mA	3500 K	11350 lm	9700 lm	123 lm/W	6.9 kg
2224135/4/... ²	CUDDLE II LED REG 72 NEMA	72 W	79 W	1000 mA	4000 K	12100 lm	10300 lm	130 lm/W	6.9 kg
2224135/6/... ²	CUDDLE II LED REG 72 NEMA	72 W	79 W	1000 mA	5000 K	12100 lm	10300 lm	130 lm/W	6.9 kg
2224137/1/... ²	CUDDLE II LED REG 96 NEMA	96 W	105 W	500 mA	2700 K	16000 lm	13650 lm	130 lm/W	9.2 kg
2224137/3/... ²	CUDDLE II LED REG 96 NEMA	96 W	105 W	500 mA	3500 K	16950 lm	14450 lm	138 lm/W	9.2 kg
2224137/4/... ²	CUDDLE II LED REG 96 NEMA	96 W	105 W	500 mA	4000 K	18000 lm	15350 lm	146 lm/W	9.2 kg
2224137/6/... ²	CUDDLE II LED REG 96 NEMA	96 W	105 W	500 mA	5000 K	18000 lm	15350 lm	146 lm/W	9.2 kg
2224139/1/... ²	CUDDLE II LED REG 120 NEMA	120 W	129 W	625 mA	2700 K	19250 lm	16400 lm	127 lm/W	9.2 kg
2224139/3/... ²	CUDDLE II LED REG 120 NEMA	120 W	129 W	625 mA	3500 K	20500 lm	17450 lm	135 lm/W	9.2 kg
2224139/4/... ²	CUDDLE II LED REG 120 NEMA	120 W	129 W	625 mA	4000 K	21700 lm	18500 lm	143 lm/W	9.2 kg
2224139/6/... ²	CUDDLE II LED REG 120 NEMA	120 W	129 W	625 mA	5000 K	21700 lm	18500 lm	143 lm/W	9.2 kg
2224141/1/... ²	CUDDLE II LED REG 144 NEMA	144 W	154 W	750 mA	2700 K	22350 lm	19050 lm	124 lm/W	9.2 kg
2224141/3/... ²	CUDDLE II LED REG 144 NEMA	144 W	154 W	750 mA	3500 K	23750 lm	20250 lm	131 lm/W	9.2 kg
2224141/4/... ²	CUDDLE II LED REG 144 NEMA	144 W	154 W	750 mA	4000 K	25150 lm	21450 lm	139 lm/W	9.2 kg
2224141/6/... ²	CUDDLE II LED REG 144 NEMA	144 W	154 W	750 mA	5000 K	25150 lm	21450 lm	139 lm/W	9.2 kg
2224146/1/... ²	CUDDLE II LED REG 192 NEMA	192 W	205 W	1000 mA	2700 K	27850 lm	23750 lm	116 lm/W	9.2 kg
2224146/3/... ²	CUDDLE II LED REG 192 NEMA	192 W	205 W	1000 mA	3500 K	29600 lm	25250 lm	123 lm/W	9.2 kg
2224146/4/... ²	CUDDLE II LED REG 192 NEMA	192 W	205 W	1000 mA	4000 K	31350 lm	26700 lm	130 lm/W	9.2 kg

CUDDLE II LED REG NEMA



2224146/6/... ²	CUDDLE II LED REG 192 NEMA	192 W	205 W	1000 mA	5000 K	31350 lm	26700 lm	130 lm/W	9.2 kg
----------------------------	----------------------------	-------	-------	---------	--------	----------	----------	----------	--------

1) tolerance +/- 5% due to LEDs accuracy

2) symbol of chosen optical system eg. 2224133/6/T2 is CUDDLE II LED REG 48 NEMA 5000K with T2 optical system

/A... – ALPHA version of the luminaire, e.g. 2224133/A/1/T3 is the CUDDLE II LED ALFA REG 48 NEMA 2700K luminaire with 32 optical system.

*For the CUDDLE II LED REG NEMA luminaire with P2 and PL optics it is possible to choose an additional light colour temperature: 5700K. The product code is then supplemented with the designation '/7'. Example: 2224133/7/P2 -CUDDLE II LED REG NEMA 48W 5700K luminaire with P2 optics

DIRECTIVES AND STANDARDS

DIRECTIVES: 2014/35/UE (Official Journal of the UE L 96/357 29.03.2014), 2014/30/UE (Official Journal of the UE L 96/79 29.03.2014), 2011/65/UE RoHS (Official Journal of the UE L 174/88 01.07.2011), 2009/125/EC(Official Journal of the UE L 285/10 31.10.2009)

STANDARDS: PN-EN IEC 60598-1: 2021-7, PN-EN 60598-2-3: 2006, PN-EN 60529: 2003, PN-EN 62262: 2003, PN-EN 62471:2010, PN-EN 55015: 2019, PN-EN 61547: 2009, PN-EN 61000-3-2: 2019 , PN-EN 61000-3-3: 2014

Lighting parameters presented based on laboratory tests according to IESNA LM-79-19

REMOVING ELECTROSTATIC CHARGE FROM LED LUMINAIRE BODY

In order to efficient discharge the electrostatic charge from the housing of LED fitting installed on the pole from dielectric material (non-conductive) one of the following solutions is required:

- functional grounding
- LED luminaire with an additional protection device

TECHNICAL DRAWING

CUDDLE II LED REG NEMA
48W, 60W, 72W

CUDDLE II LED REG NEMA
96W, 120W, 144W, 192W

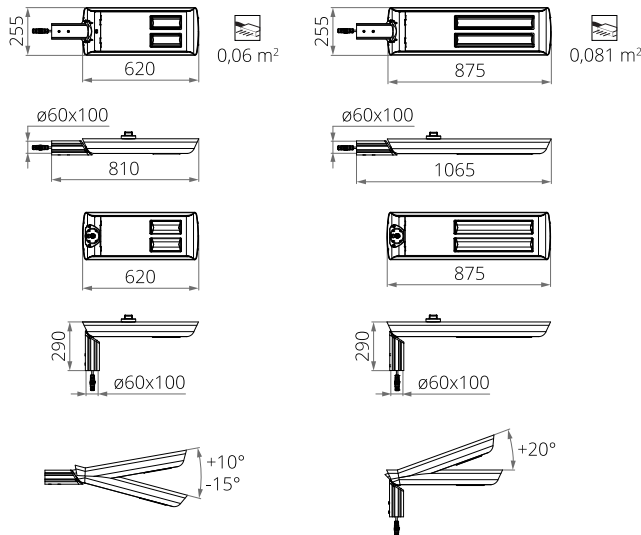

PHOTOMETRIC CURVES

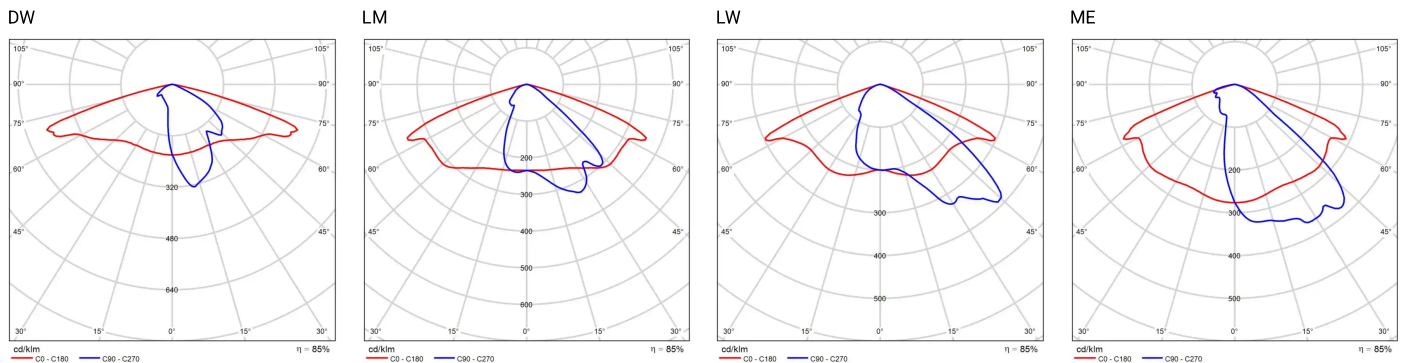

P2

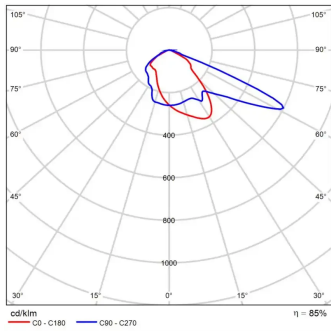

PL

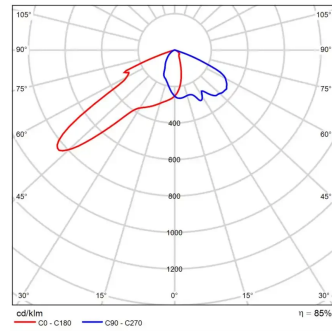

T2

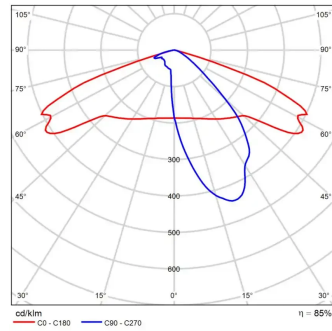

T3

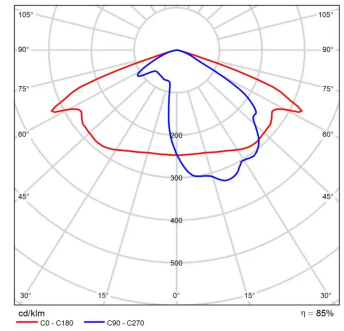

T4

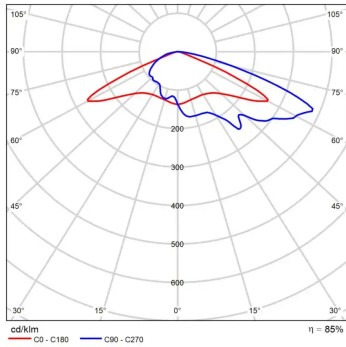

POWER SYSTEM FUNCTIONS

Luminaire in standard has following functions of intelligent power supply:

- Connection to outside control system by DALI interface (operation of analog signal 1-10V as an option),
- Possibility of programming multistage dimming of luminaire, up to 5 intervals in the range of from 10 to 100% of nominal power,
- LED module equipped with thermal protection implemented via an NTC thermistor,
- Regulation of power / luminous flux – the option of setting another value than the catalogue in the range of 30-100% of nominal one,

ACCEPTABLE QUANTITY OF LUMINAIRES ON ONE CIRCUIT

Overcurrent switches MCB type B or C

Luminaire	Typ	2A	4A	6A	10A	16A	20A	25A
CUDDLE II LED 48, 60, 72W	B	1	2	4	6	10	12	15
	C	1	4	6	10	17	20	26
CUDDLE II LED 96, 120, 144W	B	1	2	3	5	9	11	14
	C	1	3	5	9	15	18	23
CUDDLE II LED 192W	B	1	2	4	6	10	12	15
	C	1	4	6	10	17	20	26

Fuse – type gG and GL

Luminaire	2A	4A	6A	10A	16A	20A	25A
CUDDLE II LED 48, 60, 72W	0	4	8	11	22	31	44
CUDDLE II LED 96, 120, 144W	0	3	6	8	16	22	29
CUDDLE II LED 192W	1	3	5	8	14	17	22