

## TECHNICAL DATA

<b>Assembly</b>	directly on column with $\varnothing$ 60 ending or on extension arm with $\varnothing$ 60 x 100 mm ending
<b>Application</b>	motorways and expressway, urban roads, residential roads (internal), pedestrians, parkings
<b>Ingress protection</b>	IP 66 for the optical part and the driver
<b>Optical system</b>	PMMA optics, interchangeable LED module, PC-UV diffuser
<b>Material</b>	anodised aluminium alloy
<b>Unit volume</b>	0,024 m <sup>3</sup> (48 W - 72 W) 0,033 m <sup>3</sup> (96 W - 192 W)
<b>Operating temperature range</b>	from -40°C to +40°C
<b>Expected useful lifetime</b>	L90B10 - 100 000 h
<b>CRI</b>	>70
<b>Inrush current</b>	43 A / 260 $\mu$ s (48 W - 72 W) 77 A / 150 $\mu$ s (96 W - 144 W) 11,5 A / 1320 $\mu$ s (192 W)
<b>Input voltage frequency</b>	50/60Hz
<b>Power factor</b>	$\geq$ 0,95
<b>Number of LED</b>	24 (48 W, 60 W, 72 W), 64 (96 W, 120 W, 144 W, 192 W)
<b>Control system</b>	Luminaire has the possibility to connect to an external control system via DALI interface (optionally via analog signal 1- 10V).

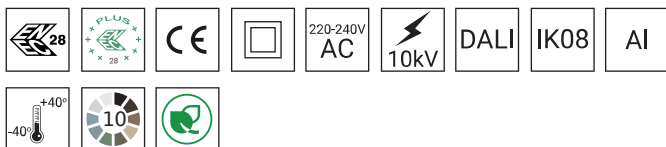

## TABLE OF VARIANTS

Code	Symbol	LED power	Luminaire power consumption	LED forward current	Colour temperature (CCT)	LEDs luminous flux <sup>1</sup>	Luminaire luminous flux <sup>1</sup>	Luminous efficacy <sup>1</sup>	Net weight
2223133/1/... <sup>2</sup>	CUDDLE II LED REG 48	48 W	55 W	700 mA	2700 K	8150 lm	6950 lm	126 lm/W	5,6 kg
2223133/3/... <sup>2</sup>	CUDDLE II LED REG 48	48 W	55 W	700 mA	3500 K	8650 lm	7350 lm	134 lm/W	5,6 kg
2223133/4/... <sup>2</sup>	CUDDLE II LED REG 48	48 W	55 W	700 mA	4000 K	9150 lm	7800 lm	142 lm/W	5,6 kg
2223133/6/... <sup>2</sup>	CUDDLE II LED REG 48	48 W	55 W	700 mA	5000 K	9150 lm	7800 lm	142 lm/W	5,6 kg
2223134/1/... <sup>2</sup>	CUDDLE II LED REG 60	60 W	67 W	830 mA	2700 K	9300 lm	7950 lm	119 lm/W	5,6 kg
2223134/3/... <sup>2</sup>	CUDDLE II LED REG 60	60 W	67 W	830 mA	3500 K	9850 lm	8400 lm	125 lm/W	5,6 kg
2223134/4/... <sup>2</sup>	CUDDLE II LED REG 60	60 W	67 W	830 mA	4000 K	10450 lm	8900 lm	133 lm/W	5,6 kg
2223134/6/... <sup>2</sup>	CUDDLE II LED REG 60	60 W	67 W	830 mA	5000 K	10450 lm	8900 lm	133 lm/W	5,6 kg
2223135/1/... <sup>2</sup>	CUDDLE II LED REG 72	72 W	79 W	1000 mA	2700 K	10700 lm	9100 lm	115 lm/W	5,6 kg
2223135/3/... <sup>2</sup>	CUDDLE II LED REG 72	72 W	79 W	1000 mA	3500 K	11350 lm	9700 lm	123 lm/W	5,6 kg
2223135/4/... <sup>2</sup>	CUDDLE II LED REG 72	72 W	79 W	1000 mA	4000 K	12100 lm	10300 lm	130 lm/W	5,6 kg
2223135/6/... <sup>2</sup>	CUDDLE II LED REG 72	72 W	79 W	1000 mA	5000 K	12100 lm	10300 lm	130 lm/W	5,6 kg
2223137/1/... <sup>2</sup>	CUDDLE II LED REG 96	96 W	105 W	500 mA	2700 K	16000 lm	13650 lm	130 lm/W	8,6 kg
2223137/3/... <sup>2</sup>	CUDDLE II LED REG 96	96 W	105 W	500 mA	3500 K	16950 lm	14450 lm	138 lm/W	8,6 kg
2223137/4/... <sup>2</sup>	CUDDLE II LED REG 96	96 W	105 W	500 mA	4000 K	18000 lm	15350 lm	146 lm/W	8,6 kg
2223137/6/... <sup>2</sup>	CUDDLE II LED REG 96	96 W	105 W	500 mA	5000 K	18000 lm	15350 lm	146 lm/W	8,6 kg
2223139/1/... <sup>2</sup>	CUDDLE II LED REG 120	120 W	129 W	625 mA	2700 K	19250 lm	16400 lm	127 lm/W	8,6 kg
2223139/3/... <sup>2</sup>	CUDDLE II LED REG 120	120 W	129 W	625 mA	3500 K	20500 lm	17450 lm	135 lm/W	8,6 kg
2223139/4/... <sup>2</sup>	CUDDLE II LED REG 120	120 W	129 W	625 mA	4000 K	21700 lm	18500 lm	143 lm/W	8,6 kg
2223139/6/... <sup>2</sup>	CUDDLE II LED REG 120	120 W	129 W	625 mA	5000 K	21700 lm	18500 lm	143 lm/W	8,6 kg
2223141/1/... <sup>2</sup>	CUDDLE II LED REG 144	144 W	154 W	750 mA	2700 K	22350 lm	19050 lm	124 lm/W	8,6 kg
2223141/3/... <sup>2</sup>	CUDDLE II LED REG 144	144 W	154 W	750 mA	3500 K	23750 lm	20250 lm	131 lm/W	8,6 kg
2223141/4/... <sup>2</sup>	CUDDLE II LED REG 144	144 W	154 W	750 mA	4000 K	25150 lm	21450 lm	139 lm/W	8,6 kg
2223141/6/... <sup>2</sup>	CUDDLE II LED REG 144	144 W	154 W	750 mA	5000 K	25150 lm	21450 lm	139 lm/W	8,6 kg
2223146/1/... <sup>2</sup>	CUDDLE II LED REG 192	192 W	205 W	1000 mA	2700 K	27850 lm	23750 lm	116 lm/W	8,8 kg
2223146/3/... <sup>2</sup>	CUDDLE II LED REG 192	192 W	205 W	1000 mA	3500 K	29600 lm	25250 lm	123 lm/W	8,8 kg
2223146/4/... <sup>2</sup>	CUDDLE II LED REG 192	192 W	205 W	1000 mA	4000 K	31350 lm	26700 lm	130 lm/W	8,8 kg
2223146/6/... <sup>2</sup>	CUDDLE II LED REG 192	192 W	205 W	1000 mA	5000 K	31350 lm	26700 lm	130 lm/W	8,8 kg

# CUDDLE II LED REG



1) tolerance +/- 5% due to LEDs accuracy

2) symbol of chosen optical system eg. 2223133/6/T2 is CUDDLE II LED REG 48 5000 K with T2 optical system

\*For the CUDDLE II LED REG luminaire with P2 and PL optics it is possible to choose an additional light colour temperature: 5700 K. The product code is then supplemented with the designation '/7'. Example: 2223133/7/P2 -CUDDLE II LED REG 48 W 5700 K luminaire with P2 optics

## DIRECTIVES AND STANDARDS

**DIRECTIVES:** 2014/35/UE (Official Journal of the UE L 96/357 29.03.2014), 2014/30/UE (Official Journal of the UE L 96/79 29.03.2014), 2011/65/UE RoHS (Official Journal of the UE L 174/88 01.07.2011), 2009/125/EC(Official Journal of the UE L 285/10 31.10.2009)

**STANDARDS:** PN-EN IEC 60598-1: 2021-7, PN-EN 60598-2-3: 2006, PN-EN 60529: 2003, PN-EN 62262: 2003, PN-EN 62471:2010, PN-EN 55015: 2019, PN-EN 61547: 2009, PN-EN 61000-3-2: 2019, PN-EN 61000-3-3: 2014, PN-EN 62722-2-1 (tq=40°C)

Lighting parameters presented based on laboratory tests according to IESNA LM-79-19

## REMOVING ELECTROSTATIC CHARGE FROM LED LUMINAIRE BODY

In order to efficient discharge the electrostatic charge from the housing of LED fitting installed on the pole from dielectric material (non-conductive) one of the following solutions is required:

- functional grounding
- LED luminaire with an additional protection device

## TECHNICAL DRAWING

CUDDLE II LED REG 48W, 60W, 72W

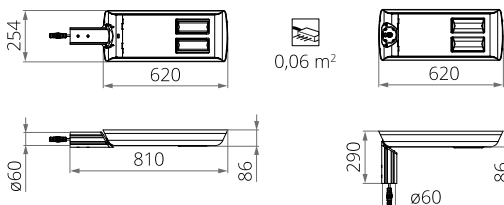

CUDDLE II LED REG 96W, 120W, 144W, 192W

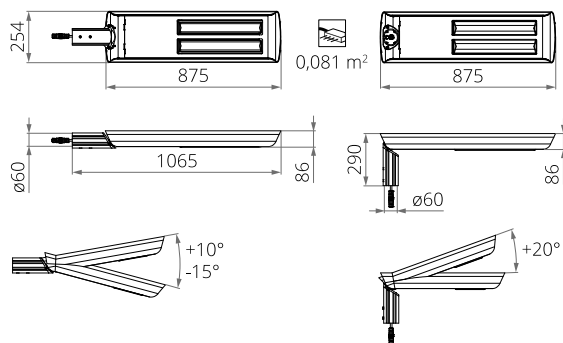

## PHOTOMETRIC CURVES

DW

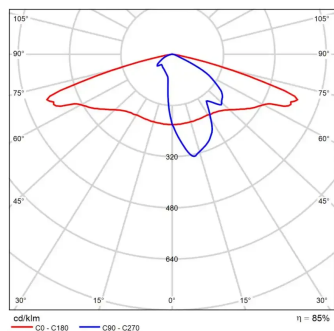

LM

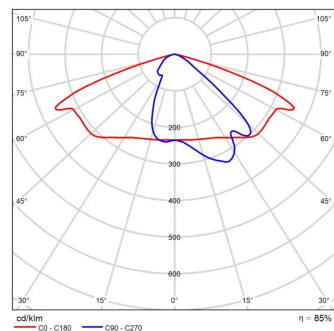

LW

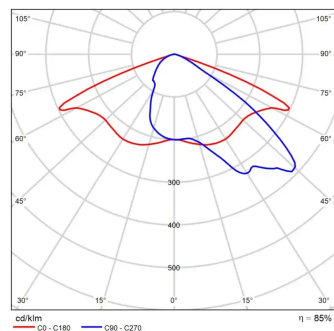

ME

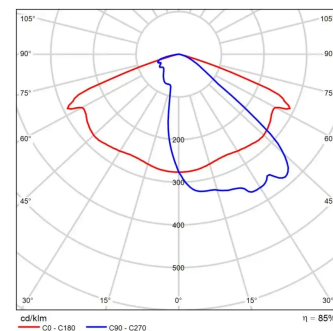

P2

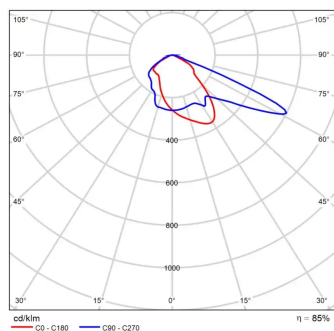

PL

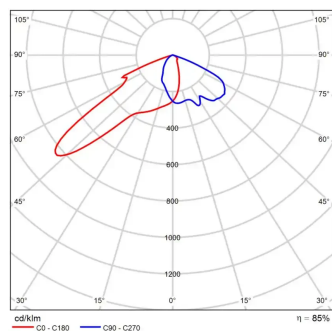

T2

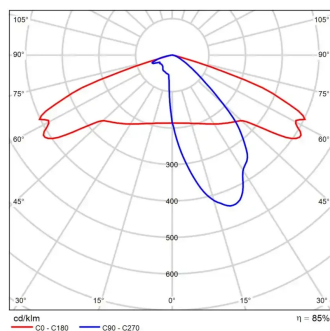

T3

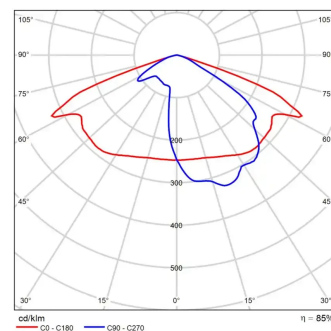

T4

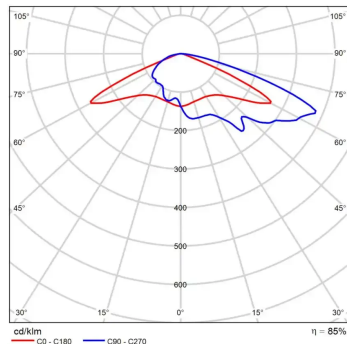

## POWER SYSTEM FUNCTIONS

**Luminaire in standard has following functions of intelligent power supply:**

- Connection to outside control system by DALI interface (operation of analog signal 1-10V as an option),
- Possibility of programming multistage dimming of luminaire, up to 5 intervals in the range of from 10 to 100% of nominal power,
- LED module equipped with thermal protection implemented via an NTC thermistor,
- Regulation of power / luminous flux – the option of setting another value than the catalogue in the range of 30-100% of nominal one,

## ACCEPTABLE QUANTITY OF LUMINAIRES ON ONE CIRCUIT

Overcurrent switches MCB type B or C

Luminaire	Typ	2 A	4 A	6 A	10 A	16 A	20 A	25 A
CUDDLE II LED REG 48 W, 60 W, 72 W	B	1	2	4	6	10	12	15
	C	1	4	6	10	17	20	26
CUDDLE II LED REG 96 W, 120 W, 144 W	B	1	2	3	5	9	11	14
	C	1	3	5	9	15	18	23
CUDDLE II LED REG 192 W	B	1	2	4	6	10	12	15
	C	1	4	6	10	17	20	26

Fuse – type gG and GL

Luminaire	2 A	4 A	6 A	10 A	16 A	20 A	25 A
CUDDLE II LED REG 48 W, 60 W, 72 W	0	4	8	11	22	31	44
CUDDLE II LED REG 96 W, 120 W, 144 W	0	3	6	8	16	22	29
CUDDLE II LED REG 192 W	1	3	5	8	14	17	22

## CHROMATICITY

Chromaticity	x	y
2700 K	0,4582	0,4099
3500 K	0,4080	0,3916
4000 K	0,3825	0,3798
5000 K	0,3451	0,3554

## PHOTOMETRIC CODE

2700 K	727/559
3500 K	735/559
4000 K	740/559
5000 K	750/559