

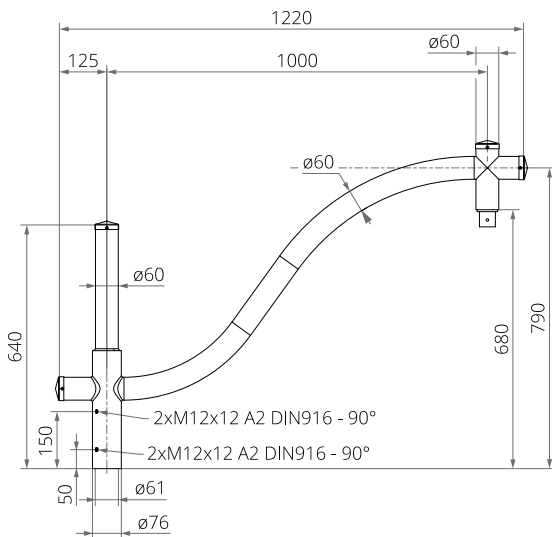

TECHNICAL DATA

Anodising	10 colours
Packing	sleeve material
Purpose	for fitting luminaires with a mounting diameter of $\varnothing 42$ mm
Assembly	on aluminium columns with a $\varnothing 60 \times 180$ mm ending
Finish	grinded, anodised aluminium
Material	anodised aluminium alloy
CE	the extension arm with the pole make a set - for extension arms, the Declaration of Performance applies to the pole on which extension arms is mounted

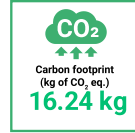

ANODISING COLOURS

