



TECHNICAL DATA

Anodising	10 colours
Packing	sleeve material
Purpose	for fitting luminaires with a mounting diameter of $\varnothing 42$ mm
Assembly	on aluminium columns with a $\varnothing 60 \times 180$ mm ending
Finish	grinded, anodised aluminium
Material	anodised aluminium alloy
CE	the extension arm with the pole make a set - for extension arms, the Declaration of Performance applies to the pole on which extension arms is mounted

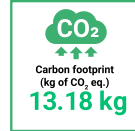
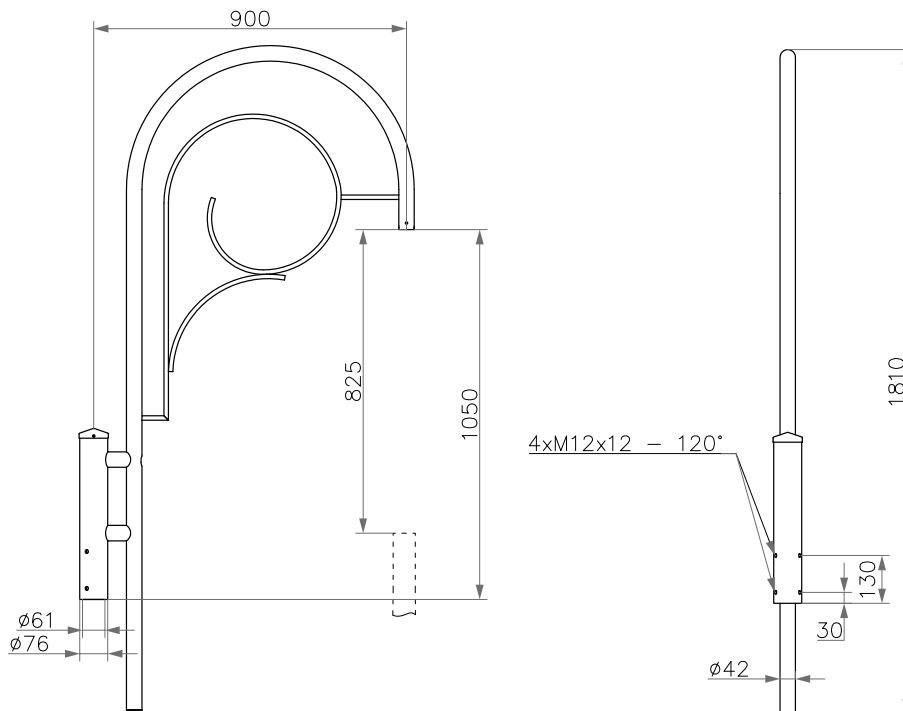

TABLE OF VARIANTS

Code	Symbol	Number of arms	Unit volume	Effective projected area	Luminaire mounting diameter	Net weight
47120101/C...	WA-20S/1 fi42	1	0.078 m ³	0.19 m ²	$\varnothing 42$ mm	5.1 kg



ANODISING COLOURS

