

Aluminium column SAL-10 Wł 2/2,5/3,7/5

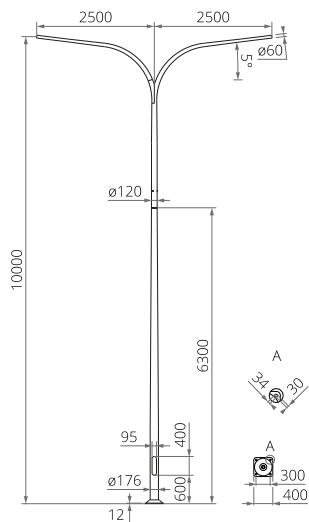

176 mm at the base plate



TECHNICAL DATA

Anodising	10 colours
Luminaire mounting	directly on the extension arm, luminaires with $\phi 60$ mm mounting with weight and surface parameters not exceeding the data from the strength table included in the technical data sheet
Packing	sleeve material
Performance under vehicle impact (passive safety)	50-NE-C-S-SE-MD-0, 70-NE-C-S-SE-MD-0, 100-NE-C-S-SE-MD-0
Diameter at the base plate	176 mm
Finish	brushed anodised aluminium - anode coating thickness is $20\mu\text{m}$ as standard (coating thickness of $25\mu\text{m}$ is also possible), option of elastomer protection up to a height of 350 mm, in a colour similar to the anode colour (other heights or colours of elastomer available according to the RAL palette at the customer's request) - the thickness of the protective coating ranges from 0.8 mm to 1.2 mm
Ingress protection	IP54 for wire chamber

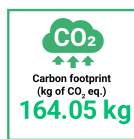

TABLE OF VARIANTS

Code	Symbol	Height of the column [H]	Unit volume	Concrete footing / reinforcement basket type	Concrete footing / reinforcement basket code	Fasteners	Net weight
42444/C...	SAL-10 Wł 2/2,5/3,7/5	10 m	0.99 m ³	B-70 / Z-70	311170 / 311207	4012	69.4 kg

STRENGTH TABLE

SAL-10 Wł 2/2,5/3,7/5		Acceptable windage of single luminaire[m ²] for Cx=1			
code 42444	Vref. = 22 m/s	Vref. = 24 m/s	Vref. = 26 m/s	Vref. = 28 m/s	
Permissible weight of a single luminaire [kg]	zone I, terrain category III	zone I & III, terrain category III up to 450m a.s.l.	zone II, terrain category III	zone III, terrain category III up to 755m a.s.l.	
15	0,14	0,07	x	x	

ANODISING COLOURS

